

Article number: 01010171
 Description: Retaining ring A 6 DIN 471
 Stainless 411
 Note: Fitted with ZGA pilers

Measures

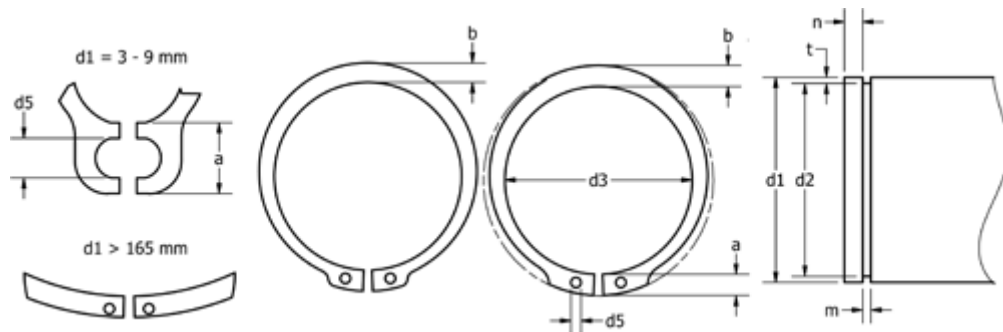

a max	= 2.7	FN kN	= 0.4	s	= 0.70
AN mm ²	= 2.8	FRg kN	= 0.90	t	= 0.15
b	= 1.3	FR kN	= 1.45	tol	= -0.04
d1	= 6	g	= 0.5	tol	= -0.05
d2	= 5.7	K kN-mm	= 10.40	tol	= +0,04-0,15
d3	= 5.6	m min	= 0.80	Tong	= ZGA-0
d5 min	= 1.2	n abl x 1000	= 114.0	Weight kg/1000	= 0.084
Description	= A6	Nominal drive	= 0.5		